

# Risk allocation for energy performance contract from the perspective of incomplete contract: a study of commercial buildings in China

Energy  
performance  
contract

457

Received 23 November 2021  
Revised 2 March 2022  
11 May 2022  
Accepted 11 May 2022

Shiyu Wan

*School of Economics and Management, Beijing Jiaotong University, Beijing, China  
and School of Built Environment, Faculty of Design Architecture and Building,  
University of Technology Sydney, Sydney, Australia*

Yisheng Liu

*School of Economics and Management, Beijing Jiaotong University,  
Beijing, China, and*

Grace Ding, Goran Runeson and Michael Er

*Faculty of Design, Architecture, and Building, University of Technology Sydney,  
Sydney, Australia*

## Abstract

**Purpose** – This article aims to establish a dynamic Energy Performance Contract (EPC) risk allocation model for commercial buildings based on the theory of Incomplete Contract. The purpose is to fill the policy vacuum and allow stakeholders to manage risks in energy conservation management by EPCs to better adapt to climate change in the building sector.

**Design/methodology/approach** – The article chooses a qualitative research approach to depict the whole risk allocation picture of EPC projects and establish a dynamic EPC risk allocation model for commercial buildings in China. It starts with a comprehensive literature review on risks of EPCs. By modifying the theory of Incomplete Contract and adopting the so-called bow-tie model, a theoretical EPC risk allocation model is developed and verified by interview results. By discussing its application in the commercial building sector in China, an operational EPC three-stage risk allocation model is developed.

**Findings** – This study points out the contract incompleteness of the risk allocation for EPC projects and offered an operational method to guide practice. The reasonable risk allocation between building owners and Energy Service Companies can realize their bilateral targets on commercial building energy-saving benefits, which makes EPC more attractive for energy conservation.

**Originality/value** – Existing research focused mainly on static risk allocation. Less research was directed to the phased and dynamic risk allocation. This study developed a theoretical three-stage EPC risk allocation model, which provided the theoretical support for dynamic EPC risk allocation of



© Shiyu Wan, Yisheng Liu, Grace Ding, Goran Runeson and Michael Er. Published by Emerald Publishing Limited. This article is published under the Creative Commons Attribution (CC BY 4.0) licence. Anyone may reproduce, distribute, translate and create derivative works of this article (for both commercial & non-commercial purposes), subject to full attribution to the original publication and authors. The full terms of this licence may be seen at <http://creativecommons.org/licences/by/4.0/legalcode>

International Journal of Climate  
Change Strategies and  
Management  
Vol. 15 No. 4, 2023  
pp. 457-478  
Emerald Publishing Limited  
1756-8692  
DOI 10.1108/IJCCSM-11-2021-0130

EPC projects. By addressing the contract incompleteness of the risk allocation, an operational method is developed. This is a new approach to allocate risks for EPC projects in a dynamic and staged way.

**Keywords** Energy performance contract, Dynamic risk allocation, Incomplete contract, Energy efficiency retrofit, Commercial buildings, Energy conservation and management

**Paper type** Research paper

### Abbreviation Explanation

AEPCA	= Australasian Energy Performance Contracting Association;
BEER	= Building energy efficiency retrofit;
C	= Consequence;
CABEE	= China Association of Building Energy Efficiency;
CSTID	= Center of Science and Technology and Industrialization Development;
DECCUK	= Department of Energy and Climate Change of UK;
EPC	= Energy Performance Contract;
ESCO	= Energy Service Company;
HVAC	= Heating, Ventilation and Air Conditioning;
ICF	= ICF (Inner City Fund) International National Association of Energy Services Companies;
IE	= Intermediate Event;
MOF	= Ministry of Finance;
MOHURD	= Ministry of Housing and Urban-Rural Development;
M&V	= Measurement and Verification;
NDRC	= National Development and Reform Commission;
PE	= Primary Event;
PPP	= Public–Private Partnership;
R	= Risk;
RLS	= Risk Liability Subject;
RPM	= Risk Preventive Measure;
RRM	= Risk Remedial Measure;
RS	= Risk Source;
SB	= Safety Barriers; and
TE	= Top Event.

## 1. Introduction

### 1.1 Research background

Climate change is one of the biggest environmental issues in the world, which leads to more extreme weather [United Nations Framework Convention on Climate Change (UNFCCC), 2021]. To keep indoor thermal comforts, more energy is consumed by heating during winters and cooling during summers (Ren *et al.*, 2011). Building energy consumption in China accounted for approximately 37% of total national energy consumption in 2018 [Building Energy Conservation Research Center, Tsinghua University (THUBECCRC), 2020]. In particular, commercial buildings account for the most (Ma *et al.*, 2017). Climate adaptation can be implemented by increasing buildings' adaptive capacity, which is represented by their enhanced energy performance to reduce the growing energy demand as a result of climate change (Ren *et al.*, 2011). Building energy efficiency retrofit (BEER) provides an effective way to reduce energy consumption through certain improvements and make buildings more adaptable to extreme warm/cold days, although it is traditionally taken as a mitigation measure (Goldman *et al.*, 2012). This also increases the adaptive capacity of an

energy supply system. Implementing BEER requires professional design and technologies and substantial capital investment. The Energy Performance Contract (EPC) is a highly recommended market mechanism for delivering BEER [National Development and Reform Commission (NDRC), 2016; Ministry of Housing and Urban-Rural Development(MOHURD) and Ministry of Finance (MOF), 2017].

EPC is a turnkey service to improve building energy efficiency. EPC as a contract can provide a contractually agreed level of energy-efficiency measures and improvements for the buildings, guaranteed energy savings and energy-saving benefits [Department of Energy and Climate Change of UK (DECCUK), 2014]. Energy Service Companies (ESCOs) provide a set of services of BEER to building owners including energy audit, project design, financing, equipment installation and maintenance [International National Association of Energy Services Companies, (ICF Inner City Fund), 2007]. The energy-saving benefits can pay for the cost of the retrofit, and anything leftover can be shared between the ESCOs and building owners. EPC is an innovative form of contract because the payment of EPC projects is based on the actual energy savings to ensure the performance of energy efficiency [Australasian Energy Performance Contracting Association (AEPCA), 2000; Bertoldi *et al.*, 2006]. Based on the performance guarantees given by ESCO, technical risks can transfer from the owner to the ESCO (Bertoldi *et al.*, 2006). There are three typical EPC business models: Shared Savings Model, Guaranteed Savings Model and Energy-Cost Trust Model (Hopper *et al.*, 2005; Shang *et al.*, 2017). The major differences between these three models concern mainly who pays the BEER, how to operate the project and who takes particular risks (Bertoldi *et al.*, 2006). The business model of EPC defines the responsibilities of building owners and ESCOs in the implementation of EPC projects and offers a way of risk sharing in an EPC project (Pätäri and Sinkkonen, 2014).

EPC has been demonstrated to improve building energy efficiency and promote the building retrofit market greatly (Zhou *et al.*, 2020). In spite of expectations, under changing economic and market conditions, climate change and unscheduled and inappropriate use of buildings, energy-saving benefits of EPCs may have been affected (Lee *et al.*, 2018; Zhang *et al.*, 2018). Therefore, EPC projects are considered to be a high-risk investment (Garbuzova-Schlifter and Madlener, 2016).

The unique partnership between ESCOs and building owners in EPCs asks for the bilateral target on energy-saving benefits (Martiniello *et al.*, 2020). Only mitigating risks of energy efficiency from a technical perspective as traditional BEER projects do is not enough to reach the goal of EPC projects. Badi and Pryke (2016) examined that clear, fair and acceptable risk allocation has a positive impact on energy-efficiency projects. Therefore, it is important to develop a reasonable risk allocation mechanism to incentivize contracting parties reaching their bilateral energy-saving target and further make up the gap that EPCs implemented in practice. Risk allocation in this research means allocating responsibilities and sharing benefits and consequences of risks of EPCs.

### 1.2 Research gap

Zhou *et al.* (2020) stated that business innovations may ensure the EPC market's sustainable development. In practice, applying EPCs in the sector of commercial buildings is hard to be guided only by the "Implementation Guidelines" and "Contract Sample Format" introduced by Center of Science and Technology and Industrialization Development, Ministry of Housing and Urban-Rural Development (CSTID) and China Association of Building Energy Efficiency (CABEE), 2014a, and Center of Science and Technology and Industrialization Development, Ministry of Housing and Urban-Rural Development (CSTID) and China Association of Building Energy Efficiency (CABEE), 2014b. These two documents only

offered a general process of conducting EPC projects but are lacking the details about how to choose an appropriate EPC business model, how to design the contract period and share energy-saving benefits between contracting parties. Although both documents mentioned the risks of conducting EPC projects, a practical risk management scheme is still absent. Therefore, stakeholders need more practical decision supports to guide them using EPCs. Addressing this issue, appropriate risk allocation with contracting parties can improve EPC project performance by negotiating and setting contract clauses regarding unforeseen scenarios (Zhang *et al.*, 2018). However, existing research has focused mainly on static risk allocation. Lee *et al.* (2015) discussed factors affecting risk allocation in EPC projects. However, they did not provide a clear picture of how to allocate these risks based on these factors. The mainstream of scholars focuses on allocating EPC risks one-off by distributing energy-saving benefits through initial contract design (Shang *et al.*, 2020; Martiniello *et al.*, 2020). Rubinstein's bargaining model and Shapley value are used to allocate benefits of energy savings in shared savings EPC projects (Shang *et al.*, 2015; Li, 2019). Some scholars have observed that risk allocation can be assessed after the bidding stages and should be taken into consideration at the contract execution stage (De Marco *et al.*, 2016).

Less research has been directed to the phased and dynamic risk allocation to discuss the risk allocation during the whole implementation process of the projects. Compared to the static risk allocation model, the dynamic risk allocation model offers the contracting parties a chance to reallocate risks by considering the new risks and their cooperation performance. The existing risk management research mainly focuses on construction projects, less on energy-efficiency projects. Wang *et al.* (2004) developed a qualitative risk management framework for international construction projects. Further, the complexity of the EPC implementation process and uncertainties makes EPC challenging to be fully specified. The incomplete contract characteristics lead to increased risk exposure for all contracting parties. As a result, some questions remain unanswered.

- Q1. How do the building owners and the ESCOs respond to the risks?
- Q2. How do they allocate the risks between them?
- Q3. Why and how is a particular risk transferred from one stakeholder to the other?

Assessing these issues is important to the success of the EPC projects.

### *1.3 Research design*

This article aims to establish a dynamic EPC risk allocation model for commercial buildings based on the theory of Incomplete Contract. Although there are many stakeholders involved in an EPC project, the focus of this article is on two groups of stakeholders only: building owners and ESCOs as they are the two key contracting parties of an EPC project.

The article chooses a qualitative research approach to depict the whole risk allocation picture of EPC projects in commercial buildings in China. Section 2 discusses the literature on the current EPC risks observed in commercial buildings. Section 3 analyses the relevant aspects of the Incomplete Contract Theory, and the theory is applied to develop a conceptual risk allocation model. Section 4 elaborates on using the so-called bow-tie model to develop a theoretical EPC risk allocation model. Section 5 uses interview results to elaborate on the validity of the theoretical model and its application in the commercial building sector in China. As a result, an EPC three-stage risk allocation model for commercial buildings is developed. Section 6 summarizes the main findings of this research, a follow-up study and policy implementation. The research design process is shown in Figure 1.

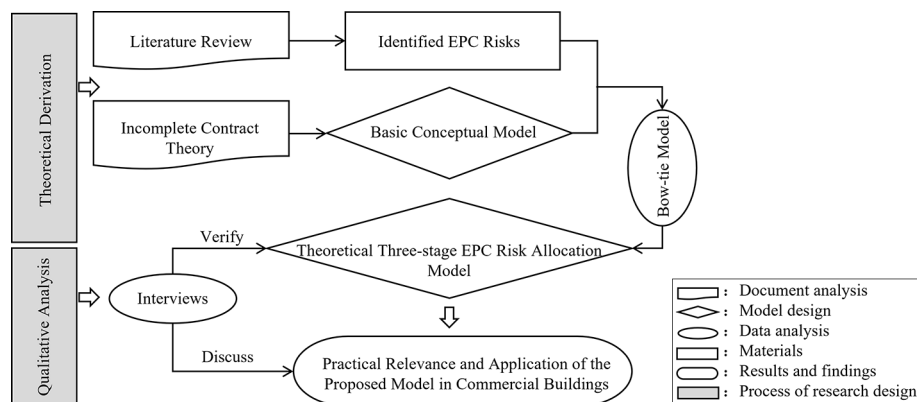

**Figure 1.**  
Research design process

## 2. The risks of EPC

A bulk of research focuses on EPC risks. Mills *et al.* (2006) identified the risks of energy-efficiency projects and classified them into five categories as economic, contextual, technological, operational, and measurement and verification risks. Then they grouped these categories into intrinsic and extrinsic factors based on how the respective risks arise. Focusing on the Chinese EPC market, Hu and Zhou (2011) identified seven main risks of EPC projects as political and legal, market, technology, management, financial, project quality and client. Lee *et al.* (2015) analysed the causes and consequences of risks of EPCs and clarified them into new seven categories of risk: economic, financial, project design, installation, technology, operational and measurement and verification. Based on their research, the risks of EPC projects are summarized in two groups: external and internal.

### 2.1 External risks

The external risks refer to the risks that come from the outside of projects and are hard to avoid when they happen, including political, market and economic risks. Policy orientation (e.g. tax exemptions and subsidies for EPCs) will influence the decisions of ESCOs and building owners, which lead to changes in their energy-saving strategies and may create financial risks for ESCOs (Wang and Sun, 2012; Garbuzova-Schlifter and Madlener, 2016; Zhou *et al.*, 2020). Market risks are caused by uncertainties in the market and may be classified by three aspects: market demand, industry competition and new market mode. Market risks have a great impact on the EPC market scale and the uptake of EPCs (Garbuzova-Schlifter and Madlener, 2016; Hu and Zhou, 2011). Economic risks are the possible economic losses that may result from variations in construction cost, interest rate, exchange rate or fuel costs (Mills *et al.*, 2006; Wang and Chen, 2008; Wang and Sun, 2012; Lee *et al.*, 2015; Garbuzova-Schlifter and Madlener, 2016; Zhang *et al.*, 2018). Those economic risks will significantly impact the profitability of EPC projects (Bannai *et al.*, 2007). Sometimes, economic risks can be changed into market risks due to the influence of price on demand.

## 2.2 Internal Risks

The internal risks refer to the risks that occur within the projects and are more measurable and controllable, including financial, project design, contract, construction, maintenance and measurement and verification (M&V) risk.

*2.2.1 Financial risk.* Financial risks appear in two contexts: the increased financial costs caused by economic risks and the payment default problem caused by inaccurate estimation of energy savings (Lee *et al.*, 2015). Tools like M&V and Investment Grade Audit are demonstrated helpful to mitigate this type of risk by considering the operational discrepancies and energy simulated with calibration with field data (Bertoldi and Kromer, 2006; Schubert *et al.*, 2021). Energy-efficiency/performance insurances could mitigate financial risks for ESCOs by transferring risks to insurance companies but in the current stage, a fair premium needs to be discussed further (Bertoldi and Boza-Kiss, 2017; NOVICE, 2020; Koutsandreas *et al.*, 2022; Töppel and Tränkler, 2019; Bonacina *et al.*, 2015).

*2.2.2 Project design risk.* The discrepancies between the expected and actual energy savings can lead to the failure of an EPC project (Yik and Lee, 2004). Project design risk is caused by two factors: insufficient information on the facility and inappropriate design. Estimating energy savings will become inaccurate when operational data are poor (Mills *et al.*, 2006; Garbuzova-Schlifter and Madlener, 2016; Borgstein *et al.*, 2018). Building energy simulation models are widely used to estimate the average energy consumption of a building; however, they only provide approximate figures with significant discrepancies (Faggianelli *et al.*, 2017). To better address this issue, a proper measurement strategy (M&V) could help to quantify and evaluate energy savings and energy baseline (Bertoldi and Kromer, 2006; Bertoldi and Kromer, 2005; Bertoldi and Boza-Kiss, 2017). Meanwhile, an energy audit has been demonstrated as a useful tool to mitigate project design risk by collecting a bulk of building energy information (Borgstein *et al.*, 2018). However, additional efforts need to be undertaken to define the informational requirements of the buildings to conduct more accurate audits (Long *et al.*, 2021).

*2.2.3 Contract risk.* Contract risk refers to the potential for an incomplete or inappropriate contract (Hu and Zhou, 2011). An incomplete contract means that a contract does not include all possible risks in advance of undertaking an EPC project. Inappropriate contracts are contracts that cannot be implemented or have difficulties to be executed (Wang and Po, 2007; Wang and Sun, 2012). There is no explicit risk pricing for an EPC project; thus, the initial risk allocation between an owner and an ESCO cannot be set in the contract precisely (Garbuzova-Schlifter and Madlener, 2017). A lack of risk-sharing strategy has been identified as a risk factor towards the contract (Koutsandreas *et al.*, 2022). Detailed responsibilities and risk-sharing mechanisms are demonstrated as a useful way to mitigate contract risk (Hu and Zhou, 2011).

*2.2.4 Construction risk.* EPC projects often involve the replacement of existing equipment with new equipment. Due to time constraints, projects may not be completed within the specified time frame (Waltz, 2003). The project delay may lead to a shortfall in energy savings. Meanwhile, inaccurate sizing, improper operation of equipment and unexpected deterioration are the triggers for construction risks (Waltz, 2003; Mills *et al.*, 2006; Garbuzova-Schlifter and Madlener, 2016).

*2.2.5 Maintenance risk.* Maintenance risks refer to inappropriate operations and management of EPC projects (Hu and Zhou, 2011; Wang and Sun, 2012). There are a lot of variations in energy savings as a result of changes in the original operation schedule and management strategies (Hu and Zhou, 2011; Shi *et al.*, 2012), like degradation of equipment, faulty operation, frequent breakdowns and unexpected consumption patterns. ESCOs would not be liable for a shortfall in energy savings when building owners do not operate the system

in accordance with the agreed control strategy and procedures (Wang and Sun, 2012; Lam and Lee, 2014; Lee *et al.*, 2015).

*2.2.6 Measurement and verification risk.* M&V risk includes modelling errors, poor data quality for M&V works, and measuring imprecision (Waltz, 2003; Mills *et al.*, 2006; Daly *et al.*, 2014). After retrofits, ESCOs and owners may have different opinions on the measurement methods, leading to project failure (Wang and Chen, 2008). Bertoldi and Boza-Kiss (2017) demonstrated that unstandardized M&V triggers the problem of lacking trust. These risks are intrinsic and can be better managed by model validation, proper measuring and implementation of recommended M&V plans (Lee *et al.*, 2015). Koutsandreas *et al.* (2022) summarized the potential risk mitigation measures for M&V risks are standardized M&V processes, careful negotiation of the measurement method and rules behind M&V.

### 3. Theoretical foundation

#### 3.1 Incomplete contract theory

*3.1.1 Incomplete contract.* Complete contract sets out the rights and obligations of contracting parties, the performance of the contract and the final result to be achieved. It assumes that there is no uncertainty and asymmetric information in the contracts (Hart, 1989). However, there is no actual complete contract in reality because contracting parties are unable to describe accurately certain events before the fact, or some clauses in the contract cannot be enforceable in the future. Incomplete contract theory stresses that complete contract sets are hard to achieve and contracts tend to be incomplete (Bolton and Dewatripont, 2005).

Williamson (1985) stated that market relationships are problematic since they require relation-specific investment taking place in a complex environment. An optimal contract should be a dynamic one and focusing on an ongoing relation instead of a static relation. The incompleteness should be dealt with through renegotiation or legal intervention (Bolton and Dewatripont, 2005). Therefore, contractual arrangements are not only in the potential completeness of contractual clauses but also in the implementation of the contract and the *ex post* support system. Seen from a time perspective an incomplete contract makes a division between the initial contract and contract renegotiation (Bolton and Dewatripont, 2005; Chung, 1991).

*3.1.2 Risk allocation in the incomplete contract.* Risk allocation is the process of dividing and distributing the responsibilities according to a particular risk under various assumptions (Uff and Odams, 1995). Risk allocation is one of the most important components of the contract design and has the same dynamic characteristic as contracts (Zhao and Yin, 2011). A trade-off between *ex ante* effort choices and *ex post* decision rights exists in an incomplete contract (Chung, 1991). Different risk allocation strategies are different trade-off choices (Jim and Dolo, 2008). The non-contractible risks should be allocated through the *ex post* renegotiation based on the now-verified efforts.

As previously discussed, the suspended trading characteristics of EPC projects (unstable energy-saving benefits in the future act as contract price) lead to a certain of uncertainties. There are a lot of risks inherent both within the particular EPC project and in the external environment. It is hard to anticipate each risk when the contract is executed and regulate all the contracting parties' responsibilities of each risk in the initial contract. The EPC is inevitably an incomplete contract. Thus, the risk allocation of EPC projects should be under a flexible mechanism between *ex ante* effort and *ex post* decision to adapt to the dynamic adjustment in the projects' execution. In this way, the incomplete contract will be optimized to the greatest extent.

3.2 Basic conceptual model

According to the analysis of the Incomplete Contract Theory, the incompleteness can be dealt with by setting an initial contract and renegotiating it. The basic sequence of contracting moves can be illustrated in Figure 2 (Chung, 1991).

The contract is designed at the initial Date 0. The initial contract regulates the class of feasible contracts and sets that the seller should transfer the goods to the buyer on Date 2. Specific investments are made independently and shortly after signing the contract, but before uncertainties  $w$  are realized. It is also assumed that the contracting parties can observe the uncertainties  $w$  that happens on Date 1. The contracting parties need to define some revision rules or negotiation options to determine a new allocation and allocate the surplus from the revision.

Based on the ideas of the Incomplete Contract theory, risk allocation can be divided into initial risk allocation and subsequent risk reallocation. The initial risk allocation and risk reallocation can be developed through the contract design and are complementary to each other. The basic conceptual model of risk allocation in an incomplete contract is shown in Figure 3.

4. Theoretical dynamic EPC risk allocation model

4.1 EPC risk allocation process

The general EPC process includes a tender phase (or bidding stage), contracting phase and EPC implementation phase (or contract execution stage) (Guo, 2016; Huang, 2016; De Marco et al., 2016).

Figure 2.  
Basic sequence of contract moves [adopted from Chung (1991)]

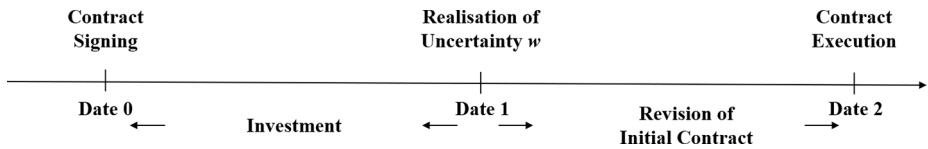
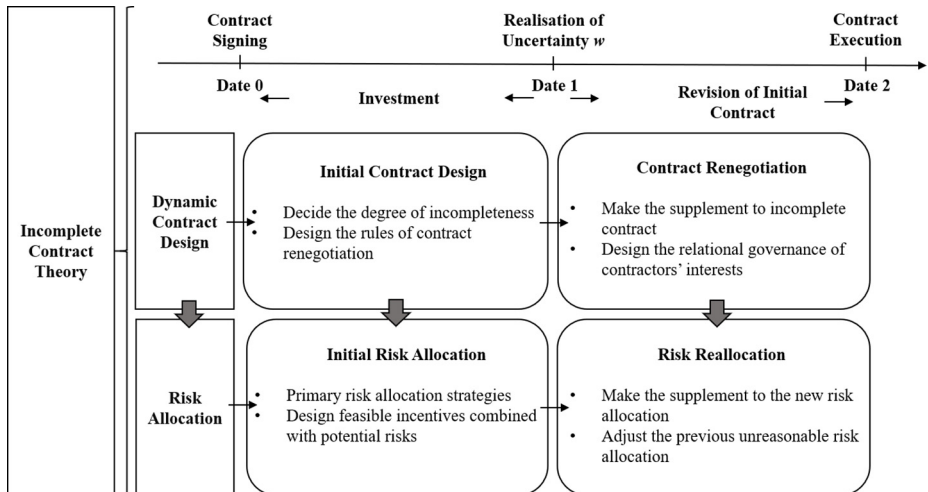

Figure 3.  
Basic conceptual model





Furthermore, these phases can be further divided into six stages: project identification, determine transaction parties, project design, contract negotiation, project implementation and management and project transfer (Xu *et al.*, 2011) (see Figure 4).

Based on the principles of risk allocation in an incomplete contract, the EPC risk allocation should be designed through the general EPC process from the contracting phase to the implementation phase. According to the detailed stages of EPCs, the EPC risk allocation process can be classified as the initial risk distribution stage, overall risk allocation stage, risk reallocation stage, corresponding to project design, contract negotiation and project implementation and management based on the contracting time sequence stated previously. The EPC risk allocation process is shown in Figure 5.

Firstly, initial risk distribution happens at the stage of project design. EPC projects spend substantial time investigating the current building energy consumption status at the project design stage. Therefore, it is the best time to consider risks and possible risk distribution strategies as defining rights and obligations. This is the preliminary work of risk allocation. When risks are identified, the overall risk allocation can be designed in the stage of contract

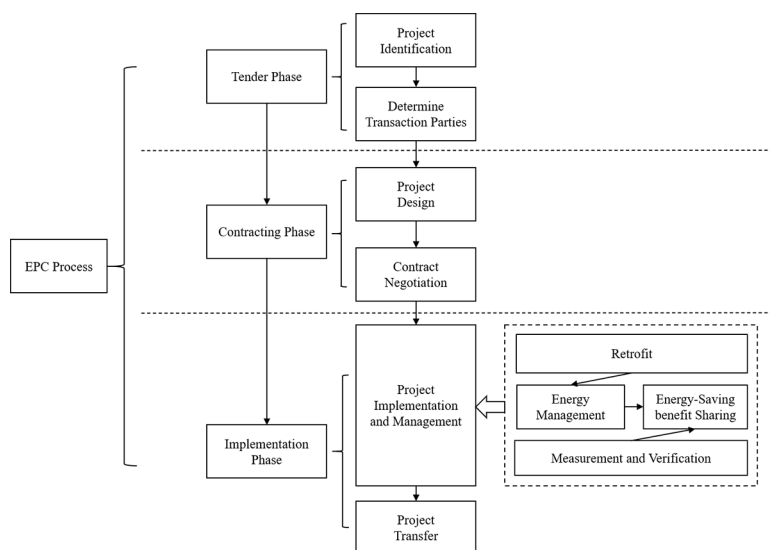

Figure 4. General EPC process

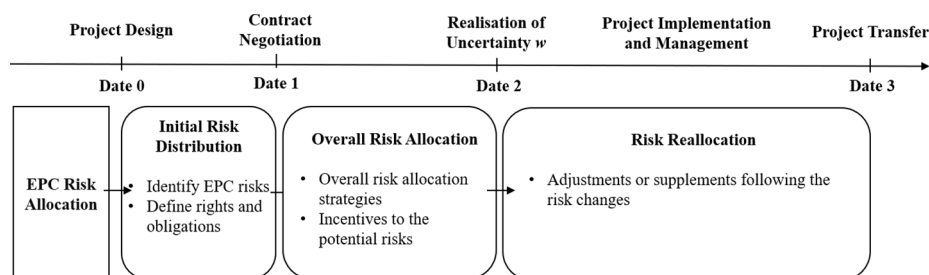

Figure 5. EPC risk allocation process

negotiations, which can be achieved by setting benefit and consequence sharing strategies. Risk reallocation may be conducted during the EPC execution as often unforeseen risks materialize during implementation.

4.2 Bow-tie model

The bow-tie model is a graphical tool used to illustrate an accident scenario, starting from accident causes and ending with its consequences (Khakzad *et al.*, 2012). It shows a complete accident scenario and describes the logical relationship among the components of a risk scenario (Khakzad *et al.*, 2012). The general bow-tie model is composed of a fault tree and an event tree and centred on a critical event that represents a threat, as shown in Figure 6 (Khakzad *et al.*, 2012).

The fault tree on the left side identifies the possible events causing the critical event (or top event), and an event tree on the right side shows the possible consequences of the critical event based on the failure or success of safety barriers. PE, IE and TE are primary, intermediate and top event, respectively. In addition, SB and C stand for safety barriers and consequences.

This article modified the general bow-tie model to analyse the EPC risks to develop a dynamic model of EPC risk allocation. The purpose is to establish:

- Which contracting party is responsible for a particular risk;
- Which type of risks can be allocated and reallocated between contracting parties; and
- How to allocate the EPC risks following the risk allocation process.

The risk subjects, risk preventive measures and risk remedial measures are added to the general bow-tie model. The intermediate event and safety barrier are reduced to show the simple relationship between the primary event (risk), the event and the consequence. The modified bow-tie model is shown in Figure 7.

In the modified bow-tie model, RLS, RS, RPM and R stand for risk liability subject, risk source, risk preventive measure and risk, respectively. In addition, RRM and C stand for risk remedial measure and consequence. The model assumes the critical event  $k$  has  $m$  risks related to risk subjects who are responsible for the corresponding risk. Each risk can be dealt with a risk preventive/mitigation measure; thus, there are  $m$  risk preventive measures in total. The critical event can lead to  $n$  consequences, and each consequence can be dealt with a risk remedial measure.

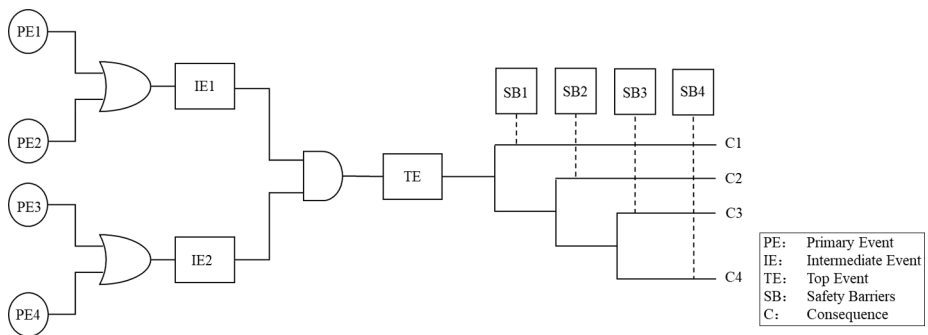

Figure 6. General bow-tie model [adopted from Khakzad *et al.* (2012)]

4.3 The development of a theoretical three-stage EPC risk allocation model

EPC risk allocation should follow the two main principles of general risk allocation: (1) risk allocation principles should be accepted by all contracting parties; (2) the contracting parties should deal with the risks they have the abilities to control, and benefits obtained should match liabilities (Ke et al., 2008; Iyer et al., 2020). Considering the characteristics of EPC projects, the risk allocation not only includes allocating responsibilities of risks but also sharing the consequences and benefits of the project by EPC business model selection, energy-saving benefit sharing and risk reallocation strategies.

Based on the previous theoretical analysis, the risk allocation of the EPC project should consider its staged and dynamic characteristics. By modifying the basic incomplete contract conceptual model, the process of risk allocation can be divided into three stages:

- (1) initial risk distribution;
- (2) overall risk allocation; and
- (3) risk reallocation.

The theoretical dynamic three-stage risk allocation model for the EPC project is developed by the modified bow-tie model shown in Figure 8.

4.3.1 Initial risk distribution. The initial risk allocation is a risk distribution process that includes identifying and estimating all foreseeable EPC risks in the project design stage. The after-risk distribution strategies should be based on the EPC business model selection.

Risk bearers can be confirmed accordingly. The risk bearers can be divided into four categories: building owners, ESCOs, shared building owners and ESCOs, and undecided. The risk bearers should take their responsibilities accurately, monitoring and managing these risks in the following stages.

4.3.2 Overall risk allocation. Overall risk allocation is in the stage of contract negotiation. In this stage, the identified potential risks can be allocated by setting the contract clauses with feasible incentives of energy-saving benefit sharing, the contract period and the rules for risk reallocation in the future. These strategies should be based on the selected business model. The target is to develop an overall risk management and sharing plan to incentivize the stakeholders. There are several rules that should be set in the contract clauses. Firstly, the risks that are difficult to obtain sufficient information to determine the probability of occurrence or extent of loss, should be dealt with in the reallocation stage. Secondly, a propping mechanism should be established to allocate risks that are not allocated in this stage.

4.3.3 Risk reallocation. Risk reallocation is the process of adjusting and redistributing new and uncertain risks in the stage of EPC project implementation and management. Adjustment or supplement that follow the external risks change and/or some unforeseen

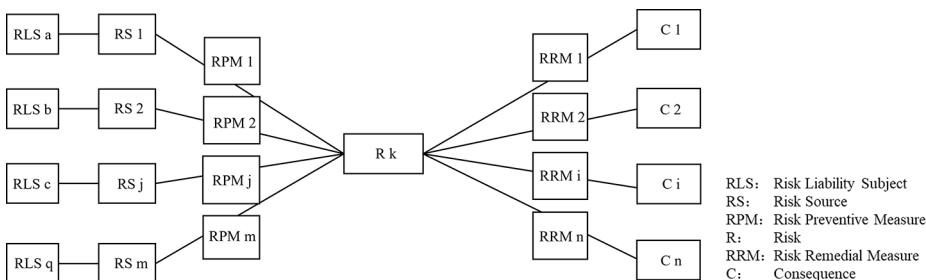
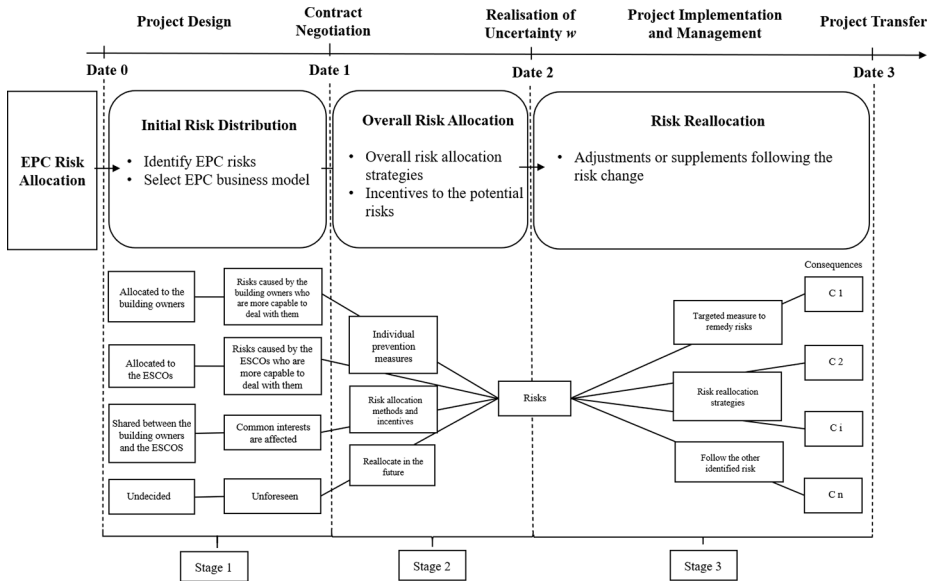

Figure 7. Modified bow-tie model



**Figure 8.**  
Theoretical three-stage EPC risk allocation model

maintenance issues happen to deal with the dynamic and phrasal characteristics of EPC risks. It aims at energy-saving benefits reallocation and contract period adjustment, which are achieved through contract clauses' adjustment or supplementary contracts. The risk tracking and reallocation is a dynamic repetitive process of the previous first two stages.

### 5. EPC risk allocation model for commercial buildings in China

The theoretical model developed in Section 4 was sent to potential interviewees to validate its practicability. This section will analyse the interview results and discuss the application of the model in the sector of commercial buildings in China. At last, a detailed three-stage EPC risk allocation is developed.

#### 5.1 Data collection

To analyse the practical relevance and application of the EPC risk allocation model in a real-world scenario, this article adopted qualitative interviews to verify the model according to the approach of business process model analysis (Becker *et al.*, 2013). Because interviews can provide a deeper understanding of applying the model than purely quantitative methods (Gill *et al.*, 2008). Coskun-Setirek and Tanrikulu (2021) developed a process model for digital innovations-driven business regeneration based on literature and semi-structured interviews. Ebrahimigharehbaghi *et al.* (2022) developed a sustainable business model of affordable zero-energy houses and the role of different institutional contexts applied in the model are explored through semi-structured interviews. Given that the proposed theoretical model related to constructs that are hard to evaluate quantitatively, using opinion-based data seemed appropriate (Ameyaw and Chan, 2015). Semi-structured face-to-face interviews were conducted with key representatives who have professional knowledge of EPCs in commercial buildings. The data sample included building owners of commercial buildings, ESCOs and independent EPC experts. Independent EPC experts are

people who have professional knowledge or work experience of EPC and work either in an academy or industry. The opinions from independent EPC experts were assessed to understand the EPC risks and key parts of EPC risk allocation. The interviews with building owners and ESCOs were based on the real EPC cases they had joined before and discussed the application of the model in an empirical context.

The contact details of building owners and ESCOs were obtained from pilot EPC projects published online. Industry contacts facilitated the initial interviews with further data collecting using a “snowball sampling” strategy, with the sample size reaching saturation point at 22 interviews (Francis *et al.*, 2010; Johnston and Sabin, 2010).

During the interviews, the questions asked focused on the existing EPC market, risks, causes of the risks, the way to avoid risks, possible measures to improve the uptake of EPCs, application of the proposed risk allocation model etc. There are seven building owners, eight ESCOs from both large- and small-scale businesses and seven independent experts. All interviews were conducted from October to November 2019 across seven cities in China (Chongqing, Beijing, Tianjin, Shanghai, Chengdu, Lanzhou and Xian). The average interview lasted approximately 45–60 min. The profile of the interviewees is shown in Table 1.

## 5.2 Data analysis

*5.2.1 Initial risk distribution.* All the interviewees believe that it is necessary to show a clear picture of the potential risks at the very beginning of the EPC projects. In the literature review, nine EPC risks have been identified (Section 2 above). From the interview results, another emergent risk associated with credit is identified. Most ESCOs stated that building owners’ credits would influence the implementation of the project. Building owners’ credits include proper energy use and payment to ESCOs on time, which directly impact energy-saving benefits and capacities to pay loans by ESCOs.

ID	Group of representatives	Position
1	Independent expert	Associate professor
2	Independent expert	Professor
3	Independent expert	Associate professor
4	Independent expert	Post-doctor
5	Independent expert	Senior lecture
6	Independent expert	Senior consultant
7	Independent expert	Senior engineer
8	Building owner	Senior property manager
9	Building owner	Senior property manager
10	Building owner	Senior engineer
11	Building owner	Senior property manager
12	Building owner	Senior property manager
13	Building owner	Senior property manager
14	Building owner	Project manager
15	ESCO	General President
16	ESCO	Senior engineer
17	ESCO	Project manager
18	ESCO	Senior manager
19	ESCO	CEO
20	ESCO	CEO
21	ESCO	Senior engineer
22	ESCO	Senior engineer

**Table 1.**  
The profile of  
interviewees

As a result, a total of ten EPC risks on commercial buildings were acknowledged. As this research focuses on risk allocation through contract design, the contract risk will not be considered directly in the model but through the process of the model development. Market risks that may influence the bidding process will not be taken into consideration in this article because risk allocation starts at the project design stage. Therefore, eight remaining risks were analysed by the modified bow-tie model in [Figure 9](#).

Except for the project design and construction risks that are only related to ESCOs because ESCOs have abilities to manage the technology-related risks. The other risks are carried by both ESCOs and the building owners. The risk allocation will concentrate on political and legal, economic, financial, maintenance and M&V risks. These risks should be avoided and mitigated and further shared by energy-saving benefit allocation combined with the other risk allocation strategies.

The external risks (political, legal and economic risk), that impact a project from the beginning to the end, will be allocated at each risk allocation stage. As regards the internal risks, the financial risk may be influenced by the economic risk and be allocated through the whole process. Maintenance and M&V risks can be avoided and mitigated by setting up the rules during the contract negotiation and be reallocated to the subsequent stage. Maintenance risks should be shared properly between building owners and ESCOs. Choosing an EPC business model can allocate these risks preliminarily because it defines the investment proportion and business relationship during the project.

Building owners' concerns concentrated on whether ESCOs can save energy as promised. Although ESCOs will pay the shortfalls in energy savings, the building owners tend to ask for guarantees. Therefore, the building owners are willing to choose the Shared Savings Model to avoid financial risk and failure of investment in energy-saving performance. This means ESCOs almost take all the potential risks in the Shared Savings Model.

All the ESCOs think there is a risk of the performance guarantee to the building owners, on both the energy maintenance and the payment of energy-saving benefit. Therefore, some of the ESCOs tend to persuade the building owners to select the Energy-cost Trust Model, because it can avoid some uncertainties occurring during the maintenance period from building owners and also guarantee the energy-saving performance.

In the first two rounds of pilot EPC projects in China, the projects which selected the Shared Savings Model could gain subsidies; therefore, both building owners and ESCOs tended to select this business model. However, at present, the subsidies had stopped. The independent experts mentioned that selecting a suitable business model based on risk preferences from contracting parties can help allocate risks to some extent. Therefore, the initial risk distribution can be conducted by choosing a suitable EPC business model for the project. Once the business model is selected, the responsibility for financial risk can be preliminarily determined.

*5.2.2 Overall risk allocation.* In the overall risk allocation stage, the focus is on sharing energy-saving benefits. All the independent experts mentioned that energy-saving benefit sharing is an important part of the EPC risk allocation. However, the strategies for energy-saving benefit sharing vary from different EPC business models. The key point of energy-saving benefit sharing in each EPC business model will be discussed below by summarizing interview results.

Under the Shared Savings Model, ESCOs bear financial risks and all the technology-related risks (project design risk, construction risk) and share maintenance risks with building owners. Without financial risks and having the performance guarantee from ESCOs, there is no loss of energy-saving benefits for building owners. Therefore, maintenance risks may be transferred to the ESCOs. In this situation, ESCOs bear most of the risks. Energy-saving benefit sharing strategies should be designed to transfer more benefits to ESCOs to compensate for financial risks and the uncertain consequences caused by building owners. Further, a component of

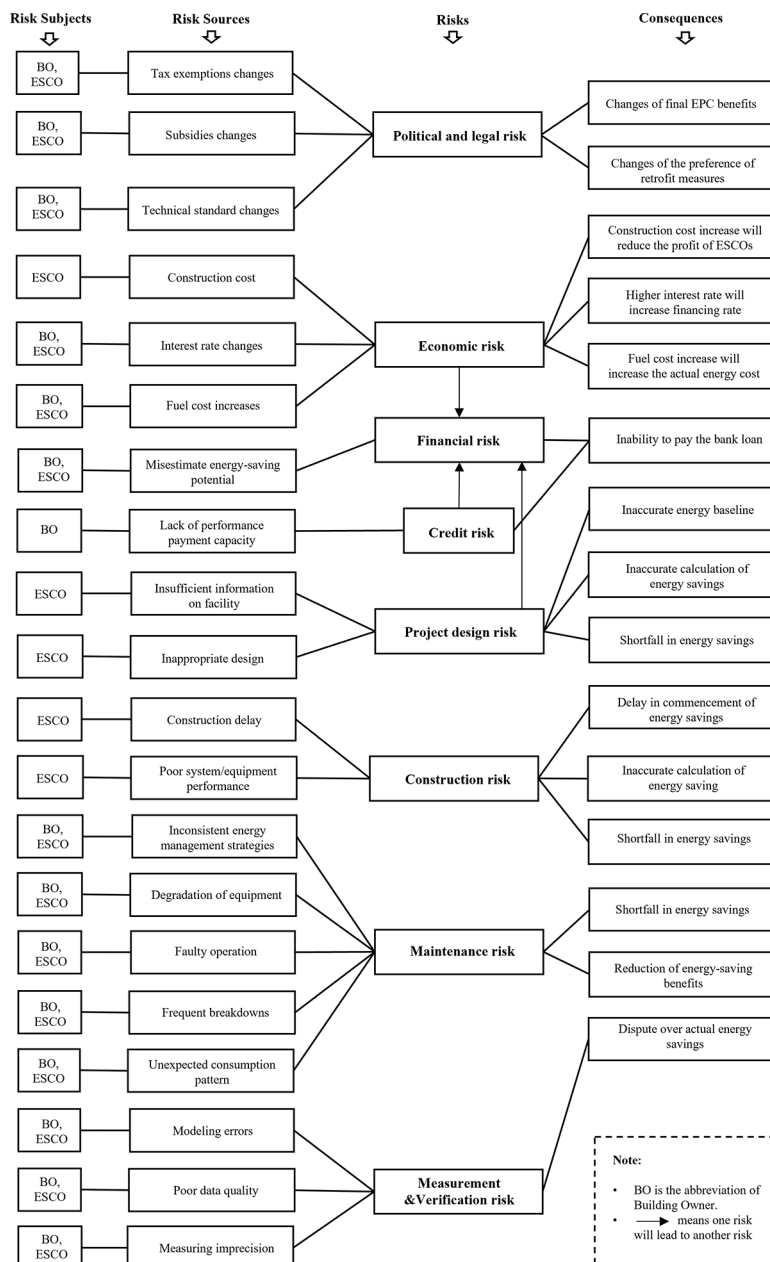

**Figure 9.**  
EPC risk identification and primary analysis by bow-tie model

energy-saving benefits should be used to incentivize building owners to bear more maintenance risks.

Under the Guaranteed Saving Model, building owners share financial and the maintenance risks with ESCOs. ESCOs compensate for the shortfalls in energy savings to building owners. Therefore, most of the maintenance risks are transferred to ESCOs. To better realize the estimated energy savings, energy-saving benefit sharing strategies should be designed to compensate for the risks ESCOs undertake and motivate building owners to cooperate with ESCOs.

Under the Energy-Cost Trust Model, building owners only bear financial risks, and ESCOs take over the whole projects bearing other risks. The performance of energy savings depends on ESCOs' serviceability. ESCOs compensate the owner for the shortfalls in energy savings. Therefore, energy-saving sharing strategies should be designed to regulate building owners' behaviours during the maintenance stage and motivate ESCOs to manage potential risks.

Most building owners stated that energy-saving benefit sharing is their motivation on following the rules set by the ESCOs. All the ESCOs and some independent experts stressed that the basis for energy-saving benefit sharing is an agreed and accurate energy consumption baseline and the related baseline measurement. Thus energy-saving benefit sharing rules should be set clearly in the contract combined with a clear technical clarification on the status of the current energy consumption level. Third-party M&V can offer some assistance here. In addition, considering the degree of motivation and how much risks are borne by each side of the contracting parties, the proportion of energy-saving benefit sharing should be designed properly to transfer some risks to some extent.

*5.2.3 Risk reallocation.* All the interviewees believed risks are hard to estimate at the start of the project and reallocating unforeseen risks in the future could help solve problems brought by the static one-off risk allocation. In this stage, the targeted measures to remedy risks should be settled and the risk reallocation should be designed by the adjustment of energy-saving benefit sharing or contract period.

Some ESCOs stated that the risks related to the technical uncertainties are sometimes hard to renegotiate because of lacking energy monitor, for example the uncertainties caused by the wrong operation of building owners. Thus, as regards maintenance risks, it is very hard to define risk liabilities. Both ESCOs and building owners state if there is a big change in building functions or using schedules, they are willing to renegotiate and sign the supplementary contract by changing the ratio of energy-benefit sharing or contract period. For the external risks, all the interviewees state it is necessary to reallocate risks because policy changes and energy price variations have a great impact on the final energy-saving benefits.

New risks can be tracked when projects enter into implementation and maintenance stages; however, the trigger of the risk reallocation is hard to decide. Independent experts support the consideration of the costs of risks. The total costs of tracking risks and negotiating the strategies of the risk reallocation should be less than the loss caused by the risks which are not addressed. Meanwhile, costs of dealing with risks and the loss due to risks are different from the ESCOs and the building owners; therefore, it should be quantified separately and then give a reference to set the trigger of the risk reallocation.

### *5.3 The EPC three-stage risk allocation model on the commercial buildings*

Based on the interview results and analysis, the detailed EPC three-stage risk allocation model on commercial buildings can be summarized in [Figure 10](#).



**Figure 10.**  
EPC risk allocation model on the commercial buildings

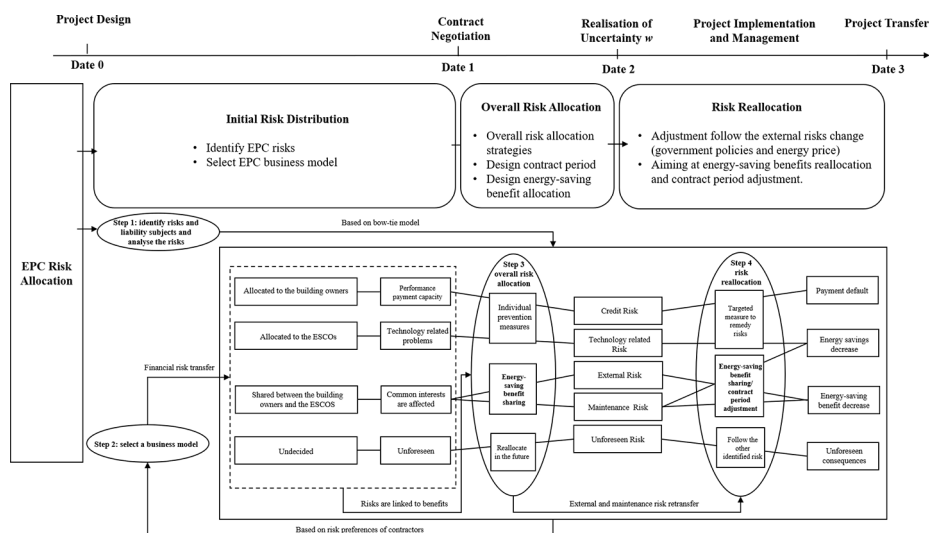

The EPC risk allocation in commercial buildings follows the three main stages with four steps. The first step is using the bow-tie model and developing a whole EPC risk picture to show all potential risks. Four types of risk liabilities (building owners, ESCOs, shared between building owners and ESCOs and undecided) are responsible for the five main types of risks (credit, technology related, external, maintenance and unforeseen risks). Based on risk preferences and the contracting parties' business situation, the second step is to select a suitable business model for EPC. The third step is to allocate risks by sharing energy-saving benefits. The fourth step is tracking the external and maintenance risks and reallocating these risks by sharing additional energy-saving benefits/losses or adjusting the contract period.

## 6. Conclusions and policy implementations

This study pointed out the contract incompleteness of the risk allocation for EPC projects and offered an operational method to fill the EPC policy vacuum. Based on a systematic analysis of incomplete contract theory, this study developed a theoretical three-stage EPC risk allocation model, which provided the theoretical support for dynamic risk allocation of EPC projects. This is a new approach to allocate risks for EPC projects in a dynamic and staged way compared to the previous one-off static risk allocation methods. EPC business model selection and energy-saving benefit sharing are highlighted as useful ways to allocate risks of EPC in the first two stages by proper risk transfer. Reallocating the unforeseen risks in the last stage helps solve the problems brought by a static one-off risk allocation. The proposed model is practical and easy to apply. It gives a reference to the building owners and the ESCOs when they try to manage and allocate risks. This reasonable risk allocation between building owners and ESCOs can realize their bilateral targets on energy-saving benefits, which makes EPC more attractive for BEER in the energy-efficiency market. It offers a risk allocation framework for all EPC markets not only in China because the theoretical model addresses all the similar barriers and uncertainties of conducting energy-efficiency projects in EPC markets.

As previous EPC projects were driven by policies (subsidies), in such an initial market, the Shared Savings model was selected mostly by the contracting parties. Business model selection, however, is one of the most important phases to allocate EPC risks. Therefore, all kinds of business models should be encouraged into use according to the real situation (financial and risk-bearing abilities) of both ESCOs and building owners. Further, in some context, modified and creative business models should also be encouraged by governments to reduce and transfer risks of building owners and ESCOs.

The foundation of a reasonable EPC risk allocation is the baseline of current building energy consumption and a relatively accurate estimation of energy savings. M&V protocols and energy audits can be assistant to guarantee the actual energy savings, which decrease the risks for the stakeholders, especially for the ESCOs, as they bear most of the risks related to technologies of energy efficiency. As the EPC process is dynamic and periodical, it is suggested to develop a dynamic risk allocation mechanism and corresponding contract clauses to achieve a reasonable EPC risk allocation. A periodical M&V service offered by the third party and a sample of supplementary contract designed by the government can be referenced for the contracting parties to adjust their energy-saving benefits for better risk allocation.

As the proposed model is qualitatively described, it presents a detailed decision procedure of risk allocation integrating the key findings of the research. With this method, however, it is hard to decide a precise ratio for quantitative risk allocation. In the future, it is necessary to combine a particular project and quantitative data to analyse the model and calculate an equilibrium point of risk allocation. Meanwhile, there is a potential limitation related to the research scope. This research is focusing on risk allocation, while according to the theory of risk management, risk mitigation is also an important part of managing EPC risks. Due to the space limitation, it is hard to discuss more details about risk mitigation strategies for EPCs. In the future, it is necessary to combine the risk allocation and mitigation strategies together to discuss the holistic path road of risk management for EPC projects.

Risks of policy and economic are suggested as the external risks that should be allocated throughout the entire period of EPC projects. Government endorsement can increase the confidence of stakeholders and increase the rate of third-party financing to further mitigate financial risks. According to the costs of conducting energy assessment during the contract negotiation and monitoring the new risks in the project maintenance period, intelligent building technologies and building information platform system can be involved to monitor the situation of building energy operation. Meanwhile, a reasonable facility management mechanism should be designed to adapt to EPCs for a more accurate energy assessment by mitigating the risks caused by uncertain energy use behaviours.

With national subsidies annulled in EPC projects, it is urgent to improve the performance of EPCs and explore an operational way to manage the risks of EPCs. The proposed model in this study offered a way to allocate risks for the EPC stakeholders. The empirical findings suggested that the innovation of the contracts and business models of EPCs, the development of M&V, energy audits, government endorsement and reasonably designed facility management mechanism are helpful to mitigate risks of EPCs. Policies may be appropriately tilted in these aspects to make EPCs more practical to building energy efficiency for better adapting to climate change.

### **Acknowledgements**

This work is supported by the National Natural Science Foundation of China under Grant No. 71871014, and the China Scholarship Council under Grant No. 20180709009. The authors express their appreciation to all the interviewees for their contributions to this research.

*Author contribution statement:* Shiyu Wan – conceptualization, data collection, formal analysis, writing – original draft; Grace Ding – supervision, writing – review and editing; Goran Runeson – supervision, writing – review and editing, Michael Er – supervision, writing – review and editing; Yisheng Liu – supervision, funding acquisition, resources.

*Ethics approval statement:* This research fulfils the requirements of the Australian Code for the Responsible Conduct of Research and UTS Research Management Policy and was approved by the Human Research Ethics Committee (HREC) of the University of Technology Sydney (UTS) on 2nd September 2019. The approval number is UTS HREC REF NO. ETH19-3793.

*Declaration of competing interest:* The authors declare that they have no known competing financial interests or personal relationships that could have appeared to influence the work reported in this article.

## References

- Ameyaw, E. and Chan, A.P. (2015), “Risk allocation in public-private partnership water supply projects in Ghana”, *Construction Management and Economics*, Vol. 33 No. 3, pp. 187-208.
- Australasian Energy Performance Contracting Association (AEPKA) (2000), *A Best Practice Guide to Energy Performance Contracts: Reducing Operating Costs through Guaranteed Outcomes*, Canberra, Commonwealth of Australia.
- Badi, S.M. and Pryke, S. (2016), “Assessing the impact of risk allocation on sustainable energy innovation (SEI)”, *International Journal of Managing Projects in Business*, Vol. 9 No. 2, pp. 259-281.
- Bannai, M., Tomita, Y., Ishida, Y., Miyazaki, T., Akisawa, A. and Kashiwagi, T. (2007), “Risk hedging against the fuel price fluctuation in energy service business”, *Energy*, Vol. 32 No. 11, pp. 2051-2060.
- Becker, J., Eggert, M., Bruning, D. and Saat, J. (2013), “Applicability of business process model analysis approaches – a case study in financial services consulting”.
- Bertoldi, P. and Kromer, S. (2006), “Risk assessment in efficiency valuation: concepts and practice”, *2006 ACEEE Summer Study on Energy Efficiency in Buildings*.
- Bertoldi, P. and Kromer, S. (2005), “Efficiency valuation – concepts and practice”, *ECEEE 2005 Summer Study – What Works and Who Delivers*, pp. 1123-1126.
- Bertoldi, P. and Boza-Kiss, B. (2017), “Analysis of barriers and drivers for the development of the ESCO markets in Europe”, *Energy Policy*, Vol. 107, pp. 345-355.
- Bertoldi, P., Rezessy, S. and Vine, E. (2006), “Energy service companies in European countries: current status and a strategy to foster their development”, *Energy Policy*, Vol. 34 No. 14, pp. 1818-1832.
- Bolton, P. and Dewatripont, M. (2005), *Contract Theory*, MIT Press, Cambridge and London.
- Bonacina, C.F., Masera, G. and Pavan, A. (2015), “Investment grade energy audit: a financial tool for the cost-effective renovation of residential buildings”, *Energy Procedia*, Vol. 70, pp. 709-718.
- Borgstein, E.H., Lamberts, R. and Hensen, J.L.M. (2018), “Mapping failures in energy and environmental performance of buildings”, *Energy and Buildings*, Vol. 158, pp. 476-485.
- Building Energy Conservation Research Center, Tsinghua University (THUBECCRC) (2020), “2020 Annual report on china building energy efficiency”.
- Center of Science and Technology and Industrialization Development, Ministry of Housing and Urban-Rural Development (CSTID) and China Association of Building Energy Efficiency (CABEE) (2014a), “Contract sample format for building energy management contract”.
- Center of Science and Technology and Industrialization Development, Ministry of Housing and Urban-Rural Development (CSTID) and China Association of Building Energy Efficiency (CABEE) (2014b), “Implementation guidelines for building energy management contract”.

- Chung, T.-Y. (1991), "Incomplete contracts, specific investments, and risk sharing", *The Review of Economic Studies*, Vol. 58 No. 5, pp. 1031-1042.
- Coskun-Setirek, A. and Tanrikulu, Z. (2021), "Digital innovations-driven business model regeneration: a process model", *Technology in Society*, Vol. 64, p. 101461.
- Daly, D., Cooper, P. and Ma, Z. (2014), "Understanding the risks and uncertainties introduced by common assumptions in energy simulations for Australian commercial buildings", *Energy and Buildings*, Vol. 75, pp. 382-393.
- De Marco, A., Rafele, C. and Thaheem, M.J. (2016), "Dynamic management of risk contingency in complex design-build projects", *Journal of Construction Engineering and Management*, Vol. 142 No. 2, p. 4015080.
- Department of Energy and Climate Change of UK (DECCUK) (2014), "The energy efficiency (Encouragement, Assessment and Information) Regulations 2014".
- Ebrahimigharehbaghi, S., van der Heijden, H. and Elsinga, M. (2022), "Sustainable business model of affordable zero energy houses: upscaling potentials", *Journal of Cleaner Production*, Vol. 344, p. 130956.
- Faggianelli, G.A., Mora, L. and Merheb, R. (2017), "Uncertainty quantification for energy savings performance contracting: application to an office building", *Energy and Buildings*, Vol. 152, pp. 61-72.
- Francis, J.J., Johnston, M., Robertson, C., Glidewell, L., Entwistle, V., Eccles, M.P. and Grimshaw, J.M. (2010), "What is an adequate sample size? Operationalising data saturation for theory-based interview studies", *Psychology and Health*, Vol. 25 No. 10, pp. 1229-1245.
- Garbuzova-Schlifter, M. and Madlener, R. (2017), "Risk analysis of energy performance contracting projects in Russia: an analytic hierarchy process approach", *Operations Research Proceedings 2015*, Springer.
- Garbuzova-Schlifter, M. and Madlener, R. (2016), "AHP-based risk analysis of energy performance contracting projects in Russia", *Energy Policy*, Vol. 97, pp. 559-581.
- Gill, P., Stewart, K., Treasure, E. and Chadwick, B. (2008), "Methods of data collection in qualitative research: interviews and focus groups", *British Dental Journal*, Vol. 204 No. 6, pp. 291-295.
- Goldman, S., Ungar, L., Capanna, C. and Simchak, T. (2012), "Energy efficiency: a tool for climate change adaptation", An Alliance to Save Energy White Paper.
- Guo, H. (2016), "Study on EPC mechanism and driving factors of energy efficiency retrofit for existing building", Science Press.
- Hart, O. (1989), "Incomplete contracts", *Allocation, Information and Markets*, Springer.
- Hopper, N., Goldman, C., McWilliams, Jennifer, B., Dave. and Stoughton McMordie, K. (2005), *Public and Institutional Markets for ESCO Services: Comparing Programs, Practices and Performance*, Lawrence Berkeley National Laboratory, Berkeley.
- Hu, J. and Zhou, E. (2011), "Engineering risk management planning in energy performance contracting in China", *Systems Engineering Procedia*, Vol. 1, pp. 195-205.
- Huang, Z. (2016), *Decision-Making Research on EPC Project of Energy-Saving Benefit Sharing Model*, Beijing Jiaotong University, Beijing.
- International National Association of Energy Services Companies, (ICF Inner City Fund) (2007), "Introduction to Energy Performance Contracting", U.S. Environmental Protection Agency ENERGY STAR Buildings.
- Iyer, K.C., Kumar, R. and Singh, S.P. (2020), "Understanding the role of contractor capability in risk management: a comparative case study of two similar projects", *Construction Management and Economics*, Vol. 38 No. 3, pp. 223-238.
- Jin, X.-H. and Doloi, H. (2008), "Interpreting risk allocation mechanism in public-private partnership projects: an empirical study in a transaction cost economics perspective", *Construction Management and Economics*, Vol. 26 No. 7, pp. 707-721.

- Johnston, L.G. and Sabin, K. (2010), "Sampling hard-to-reach populations with respondent driven sampling", *Methodological Innovations Online*, Vol. 5 No. 2, pp. 38-48.
- Ke, Y., Wang, S. and Chen, B. (2008), "Risk allocation in infrastructure public-private partnership (PPP) projects", *Construction Economy*, Vol. 4, pp. 31-35.
- Khakzad, N., Khan, F. and Amyotte, P. (2012), "Dynamic risk analysis using bow-tie approach", *Reliability Engineering and System Safety*, Vol. 104, pp. 36-44.
- Koutsandreas, D., Kleanthis, N., Flamos, A., Karakosta, C. and Doukas, H. (2022), "Risks and mitigation strategies in energy efficiency financing: a systematic literature review", *Energy Reports*, Vol. 8, pp. 1789-1802.
- Lam, T.I.P. and Lee, P. (2014), "A comparative study of standard contract conditions for energy performance contracting in Australia, Canada and the United States", *Construction Law Journal*.
- Lee, P., Lam, P.T.I. and Lee, W.L. (2015), "Risks in energy performance contracting (EPC) projects", *Energy and Buildings*, Vol. 92, pp. 116-127.
- Lee, P., Lam, P.T.I. and Lee, W.L. (2018), "Performance risks of lighting retrofit in energy performance contracting projects", *Energy for Sustainable Development*, Vol. 45, pp. 219-229.
- Li, M. (2019), *Research on Benefit Allocation of Public Building Energy Efficiency Retrofitting Based on Energy Performance Contract*, Beijing Jiaotong University, Beijing.
- Long, N., Fleming, K., CaraDonna, C. and Mosiman, C. (2021), "Buildingsync: a schema for commercial building energy audit data exchange", *Developments in the Built Environment*, Vol. 7, p. 100054.
- Ma, H., Du, N., Yu, S., Lu, W., Zhang, Z., Deng, N. and Li, C. (2017), "Analysis of typical public building energy consumption in Northern China", *Energy and Buildings*, Vol. 136, pp. 139-150.
- Martiniello, L., Morea, D., Paolone, F. and Tiscini, R. (2020), "Energy performance contracting and public-private partnership: how to share risks and balance benefits", *Energies*, Vol. 13 No. 14, p. 3625.
- Mills, E., Kromer, Steve, Weiss, G. and Mathew, P.A. (2006), "From volatility to value: analysing and managing financial and performance risk in energy savings projects", *Energy Policy*, Vol. 34 No. 2, pp. 188-199.
- Ministry of Housing and Urban-Rural Development(MOHURD) and Ministry of Finance (MOF) (2017), "Guidance for further promoting building energy efficiency plan".
- National Development and Reform Commission (NDRC) (2016), "Energy development plan for thirteenth five-year".
- NOVICE (2020), "Bankability assessment of the new EPC", European Union's Horizon 2020.
- Pätäri, S. and Sinkkonen, K. (2014), "Energy service companies and energy performance contracting: is there a need to renew the business model? Insights from a Delphi study", *Journal of Cleaner Production*, Vol. 66, pp. 264-271.
- Ren, Z., Chen, Z. and Wang, X. (2011), "Climate change adaptation pathways for Australian residential buildings", *Building and Environment*, Vol. 46 No. 11, pp. 2398-2412.
- Schubert, T., Breitschopf, B. and Plötz, P. (2021), "Energy efficiency and the direct and indirect effects of energy audits and implementation support programmes in Germany", *Energy Policy*, Vol. 157, p. 112486.
- Shang, T., Liu, P. and Guo, J. (2020), "How to allocate energy-saving benefit for guaranteed savings EPC projects? A case of China", *Energy*, Vol. 191, p. 116499.
- Shang, T., Zhang, K., Liu, P. and Chen, Z. (2017), "A review of energy performance contracting business models: status and recommendation", *Sustainable Cities and Society*, Vol. 34, pp. 203-210.
- Shang, T., Zhang, K., Liu, P., Chen, Z., Li, X. and Wu, X. (2015), "What to allocate and how to allocate? Benefit allocation in shared savings energy performance contracting projects", *Energy*, Vol. 91, pp. 60-71.
- Shi, H., Niu, D. and Wang, H. (2012), *Study of Energy Performance Contracting Project Risk Based on Fuzzy Neural Network*, Springer, Berlin Heidelberg.

- Töppel, J. and Tränkler, T. (2019), "Modeling energy efficiency insurances and energy performance contracts for a quantitative comparison of risk mitigation potential", *Energy Economics*, Vol. 80, pp. 842-859.
- Uff, J. and Odams, A.M. (1995), *Risk, Management and Procurement in Construction*, Centre of Construction Law and Management.
- United Nations Framework Convention on Climate Change (UNFCCC) (2021), "Glasgow climate pact. Draft decision", *Conference of the Parties Twenty-sixth session Glasgow*.
- Waltz, J.P. (2003), *Management, Measurement and Verification of Performance Contracting*, CRC Press, New York.
- Wang, J. and Chen, X. (2008), "Estimation of the risks of energy performance contract projects based on the unascertained measure model", *2008 IEEE International Conference on Automation and Logistics*, 1-3 Sept, 2008, pp. 1043-1047.
- Wang, T. and Po, H.U. (2007), "Operation mechanism of contract energy management plan and risk analysis", *Electric Power Technologic Economics*.
- Wang, J. and Sun, Y. (2012), "The intuitionistic fuzzy sets on evaluation of risks in projects of energy management contract", *Systems Engineering Procedia*, Vol. 3, pp. 30-35.
- Wang, S.Q., Dulaimi, M.F. and Aguria, M.Y. (2004), "Risk management framework for construction projects in developing countries", *Construction Management and Economics*, Vol. 22 No. 3, pp. 237-252.
- Williamson, O.E. (1985), *The Economic Institutions of Capitalism: Firms, Markets, Relational Contracting*, Collier Macmillan Free Press, New York, NY, London.
- Xu, P., Chan, E.H.-W. and Qian, Q.K. (2011), "Success factors of energy performance contracting (EPC) for sustainable building energy efficiency retrofit (BEER) of hotel buildings in China", *Energy Policy*, Vol. 39 No. 11, pp. 7389-7398.
- Yik, F.W. and Lee, W.-L. (2004), "Partnership in building energy performance contracting", *Building Research and Information*, Vol. 32 No. 3, pp. 235-243.
- Zhang, M., Wang, M., Jin, W. and Xia-Bauer, C. (2018), "Managing energy efficiency of buildings in China: a survey of energy performance contracting (EPC) in building sector", *Energy Policy*, Vol. 114, pp. 13-21.
- Zhao, H. and Yin, Y. (2011), "A dynamic mechanism of risk allocation of construction project from perspective of incomplete contract theory: a theoretical model", *2011 IEEE 18th International Conference on Industrial Engineering and Engineering Management*, 3-5 Sept. 2011, pp. 1816-1820.
- Zhou, Y., Evans, M., Yu, S., Sun, X. and Wang, J. (2020), "Linkages between policy and business innovation in the development of China's energy performance contracting market", *Energy Policy*, Vol. 140, p. 111208.

#### Corresponding authors

Shiyu Wan can be contacted at: [fishwansy@163.com](mailto:fishwansy@163.com) and Yisheng Liu can be contacted at: [yshliu1@bjtu.edu.cn](mailto:yshliu1@bjtu.edu.cn)